

TÖYÖTÖMI

MODEL

FF-55T/FF-55

(Type C)



GB	OPERATING MANUAL	PAGE 1
DE	GEBRAUCHSANWEISUNG	PAGE 17
FR	MANUAL D'UTILISATION	PAGE 33
NL	GEbruIKSAANWIJZING	PAGE 49

IMPORTANT

- 1) READ AND UNDERSTAND INSTRUCTIONS BEFORE INSTALLING OR USING HEATER.
- 2) RETAIN INSTRUCTIONS IN A SAFE PLACE FOR FUTURE REFERENCE.
- 3) CHECK LOCAL AUTHORITY & BUILDING CODES FOR INSTALLATION REQUIREMENTS.

SECTION A: SPECIFICATIONS

Model:	FF-55T/FF-55
Heater Efficiency:	92.4% (1)
Heat Rating:	High - 5.50 kW (18,800 BTU/h) Med - 3.74 kW (12,800 BTU/h) Low - 1.88 kW (6,430 BTU/h)
Fuel Consumption:	High - 0.622 L/h Med - 0.423 L/h Low - 0.213 L/h
Fuel System:	Removable fuel tank (7.6 L) / External tank (2)
Fuel Type:	Paraffin only
Dimensions (W × H × D):	496 × 600 × 339 mm
Weight:	20 kg/17 kg
Vent Pipe Hole:	70 ~ 80 mm diameter
Maximum Length of Vent Pipe System:	3 m, 3 bents or less (Section I “Installation”)
Electrical Rating:	230 Volts AC, 50 Hz (220 Volts AC, 50/60 Hz) (3) Preheat - 260W Burning - 48W

- (1) Heat and vaporized water are produced by fuel combustion. Heat rating does not account for heat loss due to condensation of water vapor.
- (2) External tank to be purchased separately. (Consult your supplier for options.)
- (3) It is excluded from CE marking.

SAFETY FEATURES

Your heater is equipped with a number of integral safety features. Please familiarize yourself with these features. If the heater shuts down due to the operation of any safety device, ensure the problem is identified and corrected. Note that normal combustion flames inside the combustion chamber, can be seen through a “peep hole”, located in the front bottom left hand corner of the hot air outlet louver’s.

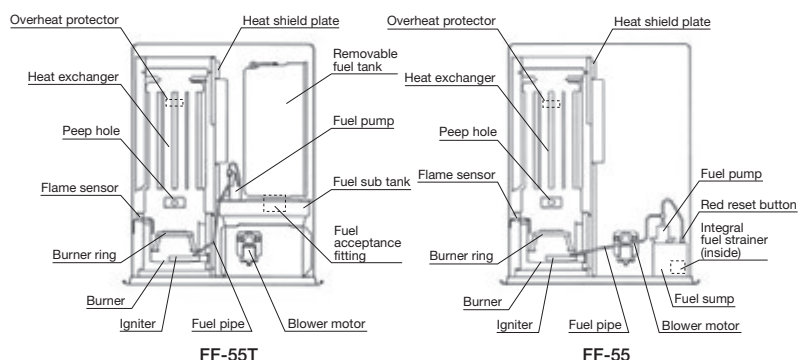

1. Flame Sensor

Heater will automatically stop all operations if ignition fails or if flame fails during combustion, in order to prevent fuel overflow. Error code will be displayed on the digital indicator.

2. Fuel Strainer

Special strainer catches any dirt or impurities present in the fuel before it is sent to the burner.

3. Overheat Protector

Automatically stops all operations if heater cabinet reaches abnormally high temperature due to motor malfunction or abnormal combustion, in order to prevent fire.

4. Power Failure Recovery System

If power fails during heater operation, heater will turn off. When power resumes, heater will automatically reignite and maintain the normal selected temperature.

NOTE: The operation varies depending on the time length of power failure and other conditions.

Please see Section E “Operation” for more details.

5. Fully Vented System

Flue pipe system provides outside air for combustion and vents all combustion products to the outdoors.

SECTION B: SAFETY TIPS FOR OPERATION

CAUTION: Heater and vent pipe system must be properly installed before operation.
Please follow instructions under “Installation”, Section I.

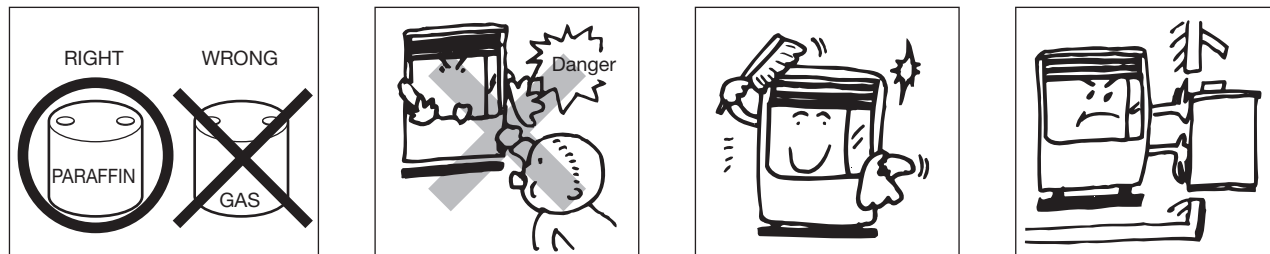

1. NEVER use any fuel other than Paraffin. NEVER USE GASOLINE. Use of gasoline can lead to uncontrollable flames, resulting in destructive fire.
2. Due to high surface temperatures, keep heater away from children, furniture and clothing while in operation. (refer to SECTION I)

- The appliance is not to be used by persons (including children) with reduced physical, sensory or mental capabilities, or lack of experience and knowledge, unless they have been given supervision or instruction.
- Children being supervised not to play with the appliance.
- This appliance can be used by children aged from 8 years and above and persons with reduced physical, sensory or mental capabilities or lack of experience and knowledge if they have been given supervision or instruction concerning use of the appliance in a safe way and understand the hazards involved.
- Children shall not play with the appliance.
- Cleaning and user maintenance shall not be made by children without supervision.

3. To prevent abnormal operation and prolong heater life, be sure to perform routine maintenance. (See Section F.)
4. NEVER store or transport fuel in other than a metal or plastic container that is acceptable for fuel and clearly marked “PARAFFIN”. NEVER store fuel in the living space.

SECTION C: FUEL GUIDE

The FF-55T/FF-55 is designed for use with Paraffin. Use of low-quality fuel will cause burner performance to drop, leading to abnormal combustion and reduced heater life.

Purchase only Paraffin, in non-red cans reserved exclusively for fuel and marked accordingly with the word “PARAFFIN”. Always store your fuel in a separate area from where you store gasoline for your power equipment to avoid accidental use of gasoline in your heater.

What to Buy . . .

- ALWAYS: Clean and high-quality Paraffin.
- ALWAYS: Fuel free of contaminants, water or cloudiness.
- NEVER: Gasoline, alcohol, white gas, camp stove fuel or additives.
- NEVER: Yellow or sour-smelling fuel.

How to Store It . . .

- ALWAYS: Store in a clean container, clearly marked PARAFFIN.
- ALWAYS: Store away from direct sunlight, heat sources or extreme temperature changes.
- NEVER: In a glass container, or one that has been used for other fuels.
- NEVER: For longer than six months. Begin each heating season with fresh fuel; discard at the end of season.
- NEVER: In the living space.

Why It is Important . . .

Pure, clean fuel is essential for safe and efficient heater operation. Poor quality or contaminated fuel can cause:

- Excess tar deposits on burner and flue pipe
- Incomplete combustion
- Reduced heater life

Use of a highly volatile flammable fuel such as gasoline can produce uncontrollable flames, creating a severe fire hazard.

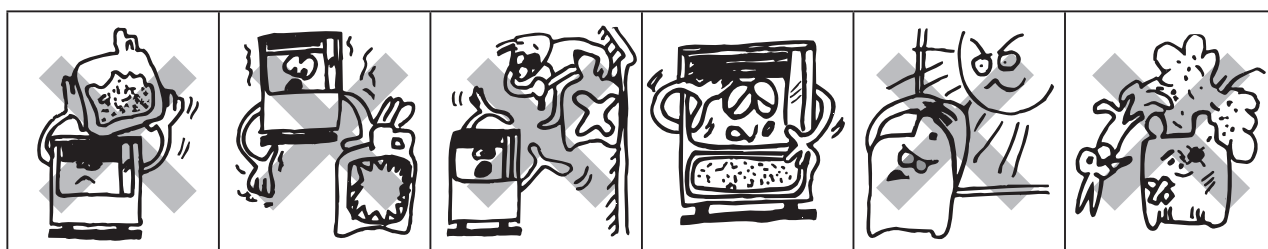

SECTION D: OPERATING CONTROLS AND PART NAMES

Before using heater, familiarize yourself with the following operating controls and part names.

FF-55T

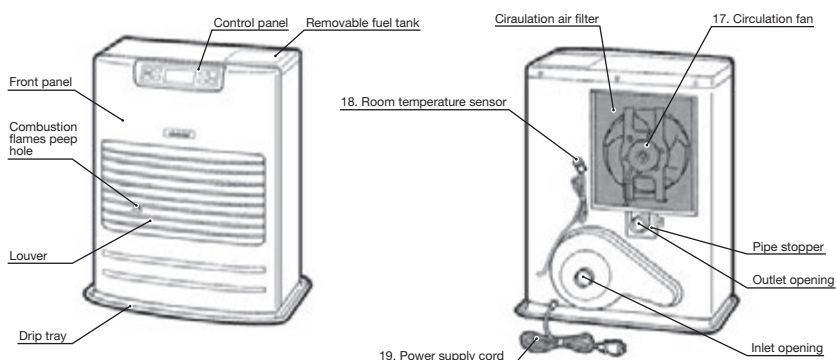

FF-55

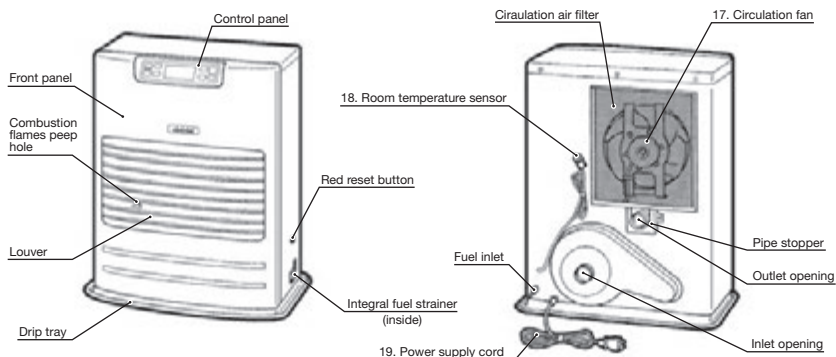

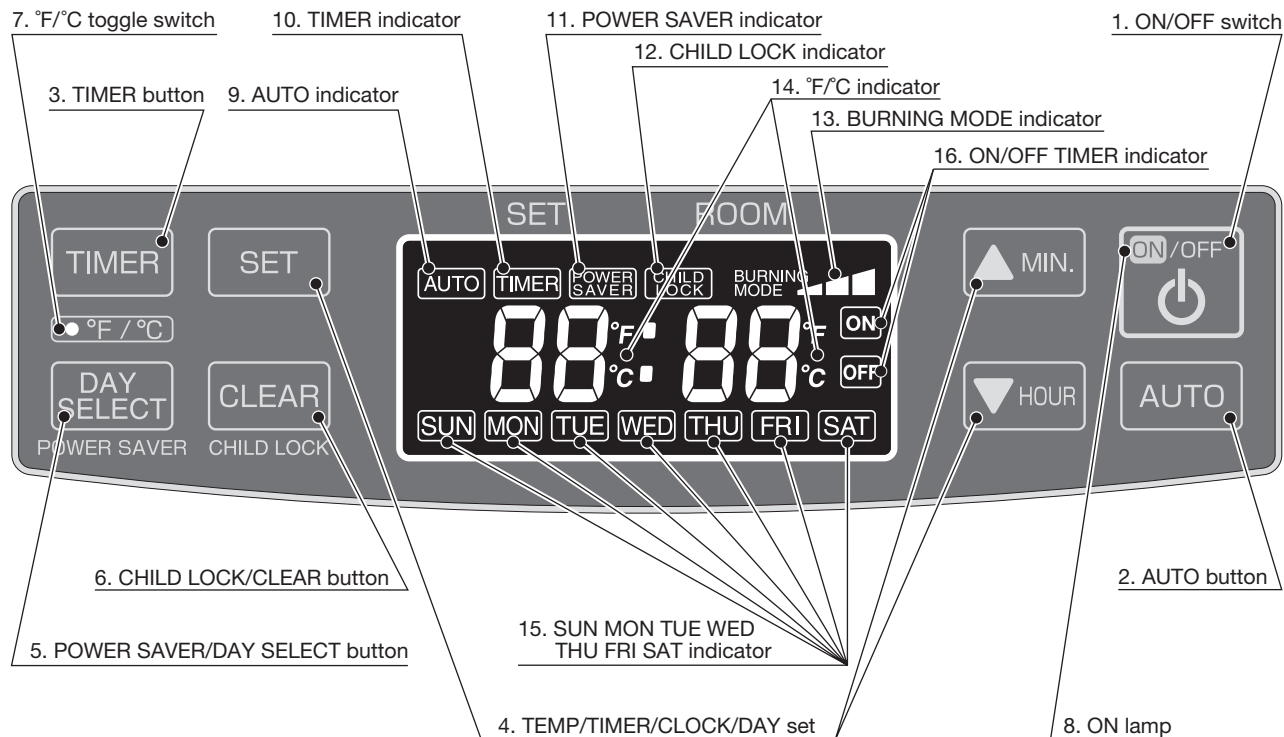

- | | |
|--|---|
| 1. ON/OFF switch: | Main switch turns heater on and off. When switched on, heater begins operation and combustion starts after preheat period. |
| 2. AUTO button: | The button turns weekly timer operation modes on and off which have been programmed into weekly timer. |
| 3. TIMER button: | The button turns weekly timer set mode on and off. |
| 4. TEMP/TIMER/CLOCK/DAY set: | TEMP/TIMER/CLOCK/DAY set modes can be set by pressing the ▲/MIN. or ▼/HOUR buttons. |
| 5. POWER SAVER/DAY SELECT button: | The button turns POWER SAVER operation mode on and off. When setting weekly timer, the button is used to select a day of the week. |
| 6. CHILD LOCK/CLEAR button: | The button turns CHILD LOCK operation mode on and off. When setting weekly timer, the CLEAR button is used. |
| 7. °F/°C switch: | °F/°C toggle switch. |
| 8. ON lamp: | Lit – Heater is in operation.
Flashing – Pre-heating and pre-purging. |
| 9. AUTO indicator: | Lit – Weekly timer operation is in use. |
| 10. TIMER indicator: | Lit – Heater operating in weekly timer set mode. |
| 11. POWER SAVER indicator: | Lit – Heater operation in POWER SAVER mode. |
| 12. CHILD LOCK indicator: | Lit – Heater operation in CHILD LOCK mode. |
| 13. BURNING MODE indicator: | Lit – Heater operation at high, medium or low combustion. |
| 14. °F/°C indicator: | Lit – Digital indicator shows current temp.
Flashing – Current temp can be changed. |
| 15. SUN MON TUE WED THU FRI SAT indicator: | Lit – Digital indicator shows current day or timer day. |
| 16. ON/OFF TIMER indicator: | Lit – Digital indicator shows ON/OFF timer. |
| 17. Circulation fan: | Three speed motor supplies high-capacity warm air flow during high combustion for heating room up quickly, and low or medium-capacity warm air flow during low or medium combustion for maintaining comfortable room temperature. |
| 18. Room temperature sensor: | Constantly senses room temperature and supplies information to heater so that desired room temperature can be maintained. |
| 19. Power supply cord: | For use in proper electrical outlet. (refer to SECTION A) |

SECTION E: OPERATION

BEFORE IGNITION

1. Filling Fuel

FF-55T:

- Do not fill the removable tank in the living room, but in a more suitable place (there can always be some spillage).
- Do not refuel the heater while in operation or still hot.

Follow the procedure below:

- 1) Make sure that the heater is switched off.
- 2) Open the tank lid and lift the removable tank out of the heater.
NOTE: Some drops may leak from the tank. Put down the removable tank (cap pointing upwards) and screw off the fuel cap.
- 3) Take the manual fuel pump and insert the smooth, most rigid tube into the can. Make sure that it is in a higher position than the removable tank. Insert the ribbed hose into the opening of the removable tank.
- 4) Lock the switch button on top of the pump (turn clockwise).
- 5) Squeeze the pump a few times, until fuel starts flowing into the removable tank. As soon as this happens, there is no need to press any longer.
- 6) Check the removable tank fuel gauge while filling the tank. Stop filling by loosening the switch button on top of the pump (turn anti-clockwise), once the gauge indicates that the tank is full. Never overfill the tank, especially not when the fuel is very cold (fuel expands when it heats up).
- 7) Let the remaining fuel in the pump flow back into the can and carefully remove the pump. Carefully screw the fuel cap back on the tank. Clean off any spilled fuel.
- 8) Check whether the fuel cap is straight and tightened properly. Reinstall the removable tank in the heater (cap down). Close the tank lid.

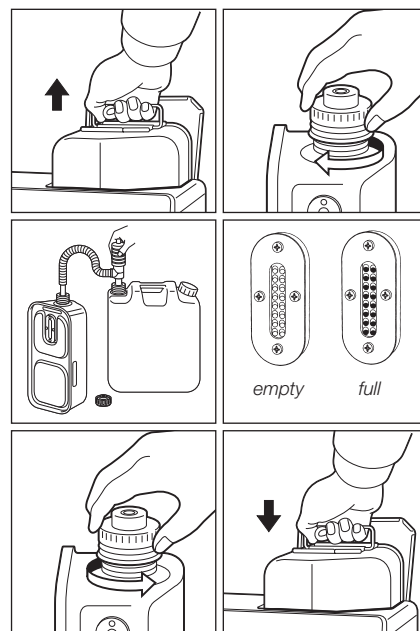

FF-55:

- 1) Open the Valve(s)
Open the valve(s) of the external fuel tank.
- 2) Start the Fuel flow
If using heater for the first time, press the red reset button in order to send fuel to the fuel sump and release.
NOTE: Make sure there is no fuel leakage from the fuel line or joints.
Also make sure fuel tank is not too high. See installation instructions.

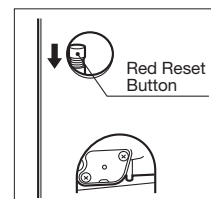

2. Connect the Heater

Connect heater into a proper electrical outlet. (refer to SECTION A).
On digital indicator pre-set "Two Dashes" will be showing.
NOTE: Do not connect to an outlet shared with other appliances.

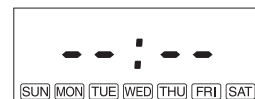

3. Set Clock

IMPORTANT: Clock on the heater must always be set to current time and day.
NOTE: In the event of a power failure (more than approx. 30 min.), all clock and day may be cancelled.

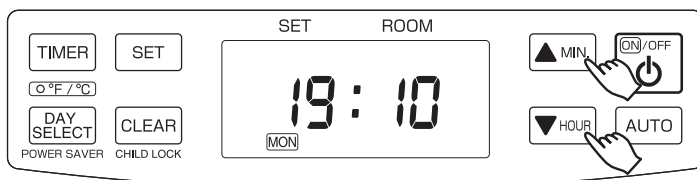

4. Setting of the Time and a Day of the Week.

- 1) Setting of the current time
 1. Press the "▲MIN." button to set minutes and press the "▼HOUR" button to set hours while in not operation.
 2. Press the "SET" button to complete the set of the current time.
- 2) Setting of a day of the week
 1. "dAy" sign is shown on the display and all of a day of the week will flash.
Press the "▲MIN." button or the "▼HOUR" button to set a day of the week.

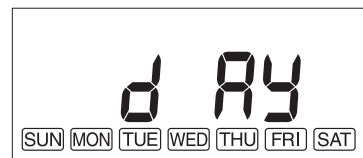

NOTE: When pressing the “▲MIN.” button at the position of “SAT”, you can hear the beep sound and “SAT” is not changed any more.

When pressing the “▼HOUR” button at the position of “SUN”, you can hear the beep sound and “SUN” is not changed any more.

- Press the “SET” button to complete the set of a day of the week. The current time and the day of week will show on the display.



OPERATION

MANUAL OPERATION

Operation of the heater is under the direct control of the user. Heat output will, however, be automatically adjusted in accordance with the room temperature registered by the temperature sensor.

1. Turning Heater ON

- Press ON/OFF switch to “ON” position. The current room temperature and the set temperature will be shown on the digital indicator. ON lamp will start to flash and then blower motor and ignition will start. This lamp will continue to flash during the preheating time.
- After approx. 1.5 – 4 minutes ignition will take place. (*) After ignition, ON lamp will change flashing to continuous. Circulation fan will turn on after approx. 2 minutes.

NOTE: (*) Pre-heating depends on the room temperature.

Room temperature:

under 0°C	4	minutes
0°C - 15°C	2	minutes
15°C	1.5	minutes

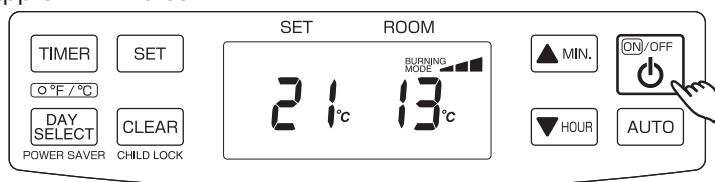

2. Adjusting Room Temperature

- Press “▲MIN.” or “▼HOUR” button. °F or °C will start to flash.
- Press “▲MIN.” or “▼HOUR” button as required. Room temperature can be set from 10°C (50°F) to 32°C (90°F). (Initial setting : 13°C (56°F))

Desired temperature setting will be displayed on the digital indicator when you set the room temperature.

When room temperature reaches the selected setting, heater will automatically shift to “MED” or “LOW” burning mode to maintain the desired temperature.

When room temperature exceeds the selected setting by approx. 2°C (4°F), the heater will automatically shut off. As room temperature drops, the heater will automatically re-start to maintain the desired temperature.

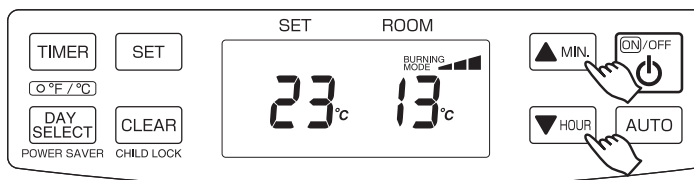

POWER SAVER OPERATION

The Power Saver mode reduces the frequency of ignition actions, to save electric consumption.

- Press the POWER SAVER (DAY SELECT) button “ON” while in operation to start the operation of the “POWER SAVER”.

“POWER SAVER” sign will be shown on the digital indicator. When the room temperature exceeds the selected setting by approximately 6°C (10°F), the heater will automatically shut off. As the room temperature becomes lower than the selected setting, the heater will automatically re-start to maintain the desired temperature.

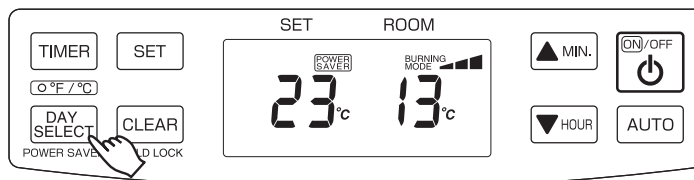

FUEL INDICATOR LIGHT (FF-55T)

When the information display lights up, **FU 10**, it means that there is only fuel left for 10 more minutes. The count down of the remaining heating time can be seen in the information display. You remove the fuel tank and refill it outside the living room. If you don't refill it, you will hear an alarm signal every two minutes, warning you to refill the removable tank. After 10 minutes the information display, **FU EL**, blinks and the heater will switch off automatically.



CHILD LOCK OPERATION

The childproof lock can be used to prevent children accidentally changing the heater settings. When the heater is burning and the childproof lock is on, the heater can only be switched off. Other functions are blocked then. If the heater has already been switched off, the childproof lock also prevents accidental ignition of the heater.

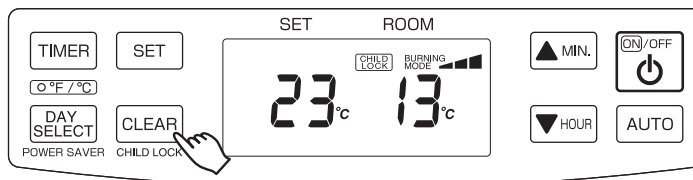

1. Press the CHILD LOCK (CLEAR) button for more than 3 seconds to set the childproof lock while in operation or not operation. "CHILD LOCK" sign will be shown on the digital indicator.
To release the child lock operation, press the CHILD LOCK (CLEAR) button for more than 3 seconds.

WEEKLY TIMER OPERATION

1. Set the Weekly Timer

After setting the current time and a day of the week, press the "TIMER" button to enter the weekly timer setting mode. The "TIMER" is shown on the display. When the "TIMER" button is pressed during setting of the weekly timer, the "TIMER" sign is disappeared and the current clock time is shown on the display.

NOTE: You cannot enter the weekly timer setting mode, while in operation at AUTO operation mode.

1) Select the program number

1. Press the "▲MIN." button or the "▼HOUR" button to select the program number.

The number of the program is 30. The unsetting program number is flashing on the display. In the case of the first setting of the weekly timer, "P01" is shown on the display and will flash. All of a day of the week will also flash.

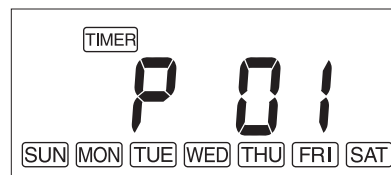

NOTE: When pressing the "▲MIN." button at the position of "P30", you can hear the beep sound and "P30" is not changed any more.

When pressing the "▼HOUR" button at the position of "P01", you can hear the beep sound and "P01" is not changed any more.

After the program is set, the next setting program number is shown on the display. If the program is set until "P30", "P30" is shown on the display. Even though the program is set until "P30", if there is the unsetting program number, the smallest unsetting program number is shown on the display.

Example:

When "P01" and "P02" programs are already set and "P03" is not set yet, the display is indicated as follows.

"P01" – lighting ⇔ "P02" – lighting ⇔ "P03" – flashing

When "P01" and "P04" programs are already set and "P02" and "P03" are not set yet, the display is indicated as follows.

"P01" – lighting ⇔ "P02" – flashing ⇔ "P03" – flashing ⇔ "P04" – lighting

2. Press the "SET" button to move to the next step (2) Set the timer).
The program number is eliminated by holding the "CLEAR" button continuously for 3 seconds.

2) Set the timer

1. Press the "▲MIN." button or the "▼HOUR" button to set timer.
2. Press the "SET" button to complete the set of timer and to move to the next step (3) Set ON/OFF of weeklytimer).

NOTE: When "SET" button is pressed when showing the bars sign on the display, you can hear the beep sound and cannot move to the next step.

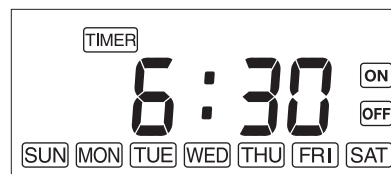

3) Set ON/OFF of weekly timer

1. [ON] and all of a day of the week will flash on the display.
Press the "▲MIN" button or the "▼HOUR" button to select [ON] or [OFF].

2. Press "SET" to complete the set ON/OFF of weekly timer.
When you set ON, the next step is 4) Set the temperature set of the program.
When you set OFF, the next step is 5) Set a day of the week of the program.

4) Set the temperature of the program

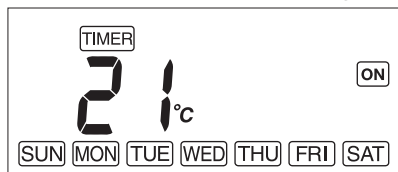

The set temperature “21” will be shown on the display and it will flash.

1. Press the “▲MIN.” button or the “▼HOUR” button to set the temperature of the program.
2. Press the “SET” button to complete the set the temperature of the program and move to the next step (5) Set a day of the week of the program).

5) Set a day of the week of the program

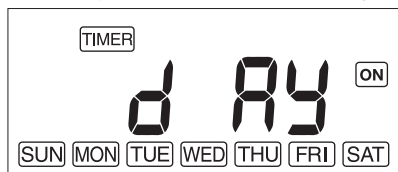

1. The “dAY” sign will be shown on the display and the “SUN” will flash. Press the “▲MIN.” button or the “▼HOUR” button to set a day of the week of the program. When pressing the “▲MIN.” button, the program is set at the day of the week. The selected day of the week will light. When pressing the “▼HOUR” button, the selected day of the week is not set. The unset day of the week will go off. At this time, the sign is moved to the next day of the week automatically.

When pressing the “DAY SELECT” button, the display will be shown the next day of the week without resetting.

2. Press the “SET” button to complete the set of a day of the week of the program and it will go back to the select of the program number.

NOTE: If no day of week is set, when pressing the “SET” button, you can hear the beep sound and cannot move to the next step.

2. Activate Weekly Timer Operation

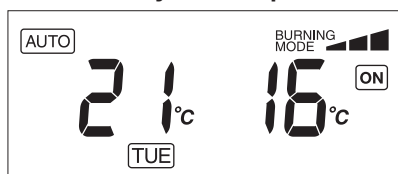

1. During operation (in a SW/ON position), press the “AUTO” button to enter the weekly timer operation mode. The “AUTO” sign will be shown on the display.

NOTE: If no program is set, you can hear the beep sound and cannot enter the weekly timer operation mode.

2. Press the “▲MIN.” button or the “▼HOUR” button to change the set temperature.

NOTE: If the next program starts, the temperature will be changed to the temperature of the next program.

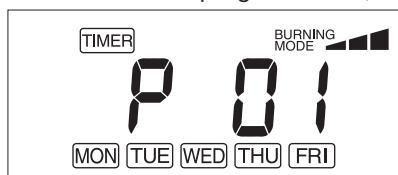

3. During operation, press the “TIMER” button to enter the weekly timer set mode (Select of the program number).

NOTE: If the “TIMER” button is pressed during the setting of the weekly timer set mode, the weekly timer set mode is released.

Change of setting is applied as soon as the AUTO operation starts.

NOTE: If ON/OFF switch is pressed during the weekly timer operation mode, the weekly timer operation mode is canceled.

MANUAL COMBUSTION

IMPORTANT: This feature is for testing purpose only!

This heater also can be kept burning at desired combustion mode (High, Medium or low) manually, regardless of room temperature.

1. Press the “▲MIN.” button and “▼HOUR” button at the same time for more than three (3) seconds when ON / OFF switch is “ON”.
2. P1, P2 or P3 will be displayed on the Digital indicator;
 - P1 = Low mode
 - P2 = Medium mode
 - P3 = High mode

Then select desired combustion mode by pressing “▲MIN.” or “▼HOUR” button. “▲MIN.” button changes combustion mode to higher, “▼HOUR” button changes combustion mode to lower.

3. To clear, press the “▲MIN.” button and “▼HOUR” button at the same time for more than (3) seconds until normal temperature display returns.

AUTOMATIC CLEANING MODE

When the heater has been burning continuously for two hours at its highest setting, the burner will automatically start an auto clean procedure. The display will show the auto cleaning code cl:05 running back to cl:01. The procedure takes 5 minutes to clean the burner automatically while the heater will burn at its lowest setting. When the burner is clean again, the heater will automatically switch back to the highest setting again.

POWER FAILURE RECOVERY SYSTEM

If at any time a power failure occurs during operation, heater will turn off. When the power returns, the unit will automatically restart with the following conditions. Please reset each setting when the settings are erased as indicated below.

WHEN HEATER IS IN OPERATION

TIME LENGTH OF POWER FAILURE	LESS THAN 3 SECONDS	MORE THAN 3 SECONDS	
		IN BACKUP MEMORY	OUT OF BACKUP MEMORY
OPERATION	Restart the combustion with the same condition before the power failure.	Start the combustion from the beginning.	Start the combustion from the beginning. Set temperature will change to 13°C (56°F) for safety. Set temperature and room temperature will blank that at least more than 30 min. power failure has occurred. To stop the blinking the set temperature and room temperature, press any button once.
POWER SAVER OPERATION	Keep the same condition before the power failure.	Keep the same condition before the power failure.	Keep the same condition before the power failure.
AUTO OPERATION	Keep the same condition before the power failure.	Keep the same condition before the power failure.	The setting will be erased. (refer to SECTION E)
CHILD LOCK OPERATION	Keep the same condition before the power failure.	The setting will be erased. (refer to SECTION E)	The setting will be erased. (refer to SECTION E)

If at any time a power failure occurs when heater is not in operation, the unit will basically start the operation while keeping the same condition before the power failure. However, when the power failure continued more than 3 seconds, the following settings will be erased. Please reset each setting.

WHEN HEATER IS NOT IN OPERATION

IN BACKUP MEMORY	Child lock operation
OUT OF BACKUP MEMORY	Clock and Day setting
	Child lock operation

TURNING HEATER OFF

Press ON/OFF switch to “OFF” position. ON lamp will flash and will go out. Circulation fan and blower motor continue to run for approx. three (3) minutes to cool down the heater.

NOTE: ON lamp goes out when the fan stops.

NOTE: If ON/OFF switch is pressed during the weekly timer operation mode, the weekly timer operation mode is canceled.

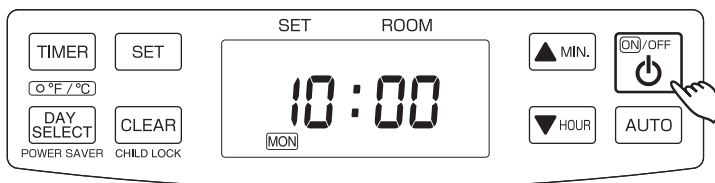

SECTION F: ROUTINE MAINTENANCE

CAUTION: Be sure to disconnect heater before performing any checks or cleaning.

CAUTION: Allow heater to cool completely before cleaning or maintenance.

FOR OPTIMUM HEATER PERFORMANCE, THE PARTS SHOWN BELOW SHOULD BE CLEANED REGULARLY:

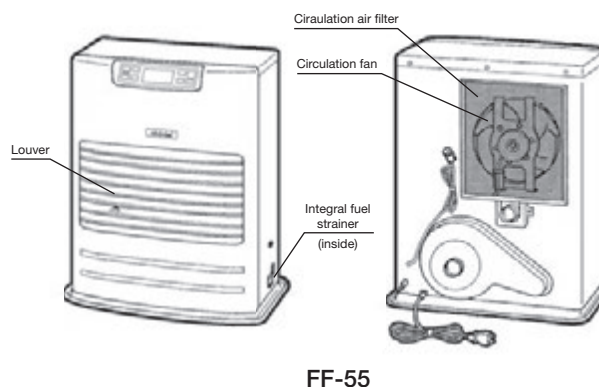
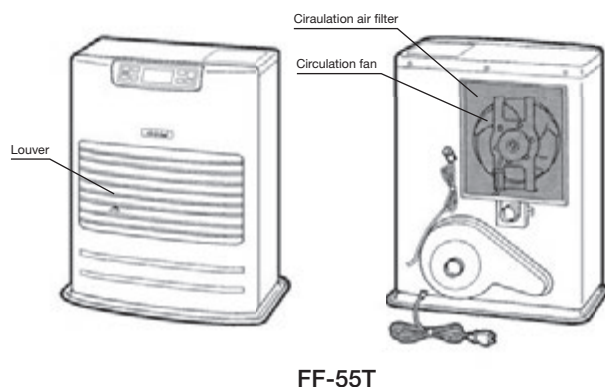

1. Clean Louvers (ONCE A WEEK)

Dust and stains should be wiped off louvers with a damp cloth.

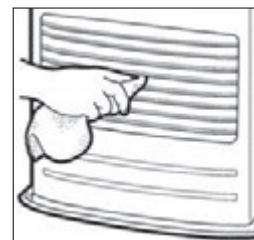

2. Clean Circulation Air Filter (ONCE A WEEK)

A mesh filter is located on heater cabinet rear side. Once a week slide the filter up to remove and it should be vacuumed clean.

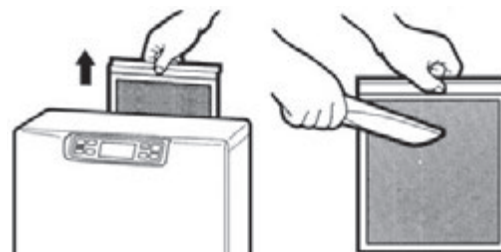

3. Clean Fuel Acceptance Fitting (FF-55T)

When dirt or dust accumulates in the fuel acceptance fitting, it should be cleaned. Check fuel acceptance fitting each time your refuel.



4. Check for Fuel Leaks (REGULARLY)

FF-55T: Make it a habit to check for signs of fuel leakage. Wipe off any spilled fuel on the sub tank and removable fuel tank. Spilled fuel may cause odor or risk of fire.

FF-55: Make it a habit to check for any sign of fuel leakage along the fuel line and at all joints. Fuel leaks may lead to risk of fire.

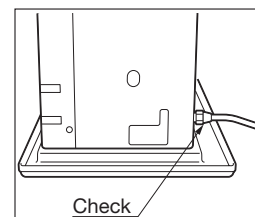

5. Check Flue Pipe Area (ONCE A WEEK)

Check the flue pipe joint to make sure connection is firm. Use a vacuum cleaner to remove any dust or pet hair.

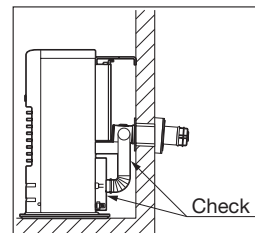

6. Clean Fuel Strainer (ONCE A MONTH) (FF-55)

The strainer of the fuel sump should be cleaned once a month and before storing heater at the end of each season.

- Close the valve(s) of the separate fuel tank.
- To catch the fuel which will drain out, set the oil catch below the strainer cover, with a small container under it.
- Loosen the two screws from the strainer cover and remove.
- Remove the strainer and wash with fuel.
- Return the strainer to its original position. Replace strainer cover and screw to secure.
- Wipe away any spilled fuel.
- Open the valve(s) of separate fuel tank. Check for fuel leakage.

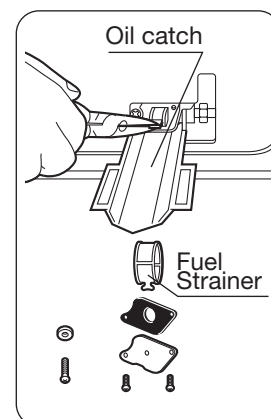

NOTE: Be sure to unscrew the drain screw to remove all remaining fuel from the fuel sump at the end of each season.

7. Recommended Periodic Maintenance

As a state-of-the-art furnace, your heater requires periodic inspection and service by an authorized technician to insure optimum, trouble free performance. This inspection should include: a combustion check; flue pipe check; burner assembly check; cleaning all necessary parts and replacing gaskets as needed. Please ask your authorized TOYOTOMI dealer for details and scheduling.

AUTOMATIC IGNITER CLEANING SYSTEM

The igniter cleaning mode prolongs the igniter life.

When the heater is on and clock is set (See "Set Clock" SECTION E), it will automatically stop and clean the igniter every day at 2:00 and will display "CL" on the digital indicator. After the cleaning mode is finished the heater will automatically re-ignite and continue to burn again.

MANUAL IGNITER CLEANING SYSTEM

Heater will clean igniter for ten (10) minutes manually.

- When ON/OFF switch is "OFF", press the "SET" button and "CLEAR" button at the same time for more than three (3) seconds.
- Display will appear "CL:10" on Digital indicator. Cleaning will begin and end without any additional input.

NOTE: Cleaning igniter is important to prolong igniter life. It is recommended that the igniter be cleaned once a week.

SECTION G: TROUBLESHOOTING

BEFORE REQUESTING A SERVICE CALL

The following symptoms are normal during operation of the heater.

	CONDITION	REASON
When heater is started or extinguished.	White smoke or smell inside home when the heater is first used.	Machine oil used in factory assembly, or transit dust burns off the surfaces of the burner or heat exchanger.
	Flashing flames visible in viewing window for a few minutes after ignition.	The burner is cold and igniter is kept running for a while after.
	Irregular metallic "cracking" noises when when heater is ignited or extinguished.	Expansion / contraction of hot metal components within the heater warming and cooling.
	Warm air is not discharged as soon as ignited.	Delay is to prevent nuisance cool air.
	Audible "chugging sound" from fuel pump.	Air is in the fuel pump (No fuel). At first "Start Up" the rapid "chugging noise", may continue for a minute or two, until air is purged from the pump*.
When heater is in operation.	Regular pulse "Ticking" noise from heater.	Sound of fuel pump in normal operation.
	Heat chamber or heat exchanger can be seen through the air outlet louver's glowing red hot.	Normal
	Occasional yellow flickering in blue flame.	Normal

*If rapid "chugging" sound from fuel pump does not cease and if heater shuts OFF.....

1. Push Fuel Sump Red Reset Button. (refer to SECTION E) DO NOT hold down.
2. Insure that all valves (including fire valve) are open.
3. Insure external fuel tank has fuel and fuel filters are clean.

ERROR CODE	INFORMATION	WHAT TO DO
E-0	Power failure (low voltage, unstable frequency)	Check power source.
E-2	Ignition safety feature is activated. / No fuel (FF-55)	Contact your dealer. / Refill fuel. If the fuel is remained in the tank, check the fuel line. (FF-55)
E-6	Extinguished during operation. / No fuel (FF-55)	Contact your dealer. / Refill fuel. If the fuel is remained in the tank, check the fuel line. (FF-55)
E-8	Blower motor malfunction	Contact your dealer.
E-12	Overheating safety feature is activated.	Clean the air filter and remove dust.
E-13	Burner thermistor malfunction	Contact your dealer.
	Excess fuel in the burner	Contact your dealer.
E-22	Ignition failure three times	Contact your dealer.
E-23	Primary flame rod (Flame sensor) is malfunction and/or dirty	Consult your dealer.
FUEL	No fuel (FF-55T)	Refill fuel. (FF-55T)
-- : --	Timer is not setting.	Set the timer.
Hi	Room temperature is higher than 35°C (95°F). Position of room temperature sensor is not correct.	Check the position of room temperature sensor. / Contact your dealer.
Lo	Room temperature is lower than -10°C (14°F). Room thermistor malfunction or disconnected.	Check the position of room temperature sensor. / Contact your dealer.

SECTION H: LONG TERM STORAGE

At the close of each heating season, or when you do not plan to use your heater for an extended period, the following procedures are recommended.

1. As the end of the season approaches, calculate your fuel purchases so that you can use up all the fuel you have on hand. When fuel is stored for over six months, its quality may deteriorate. The use of such fuel will have an unfavorable effect on heater operation.
2. If your heater needs any service or repair, now is the time to call your dealer and get it done before storage. That way your heater will be ready for immediate use when the next heating season begins.
3. If you plan to store your heater in place,
 - (a) Disconnect power supply.
 - (b) FF-55T: Clean the fuel acceptance fitting and remove any paraffin, dust or water remaining in the fuel sub tank and removable fuel tank to prevent rusting. (Refer to SECTION F)
FF-55: Close the main tank valve. Remove all fuel from the fuel sump and clean the fuel strainer. (See "Clean Fuel Filter" on SECTION F)
 - (c) Wipe off any stains or dust on heater with a damp cloth, then wipe once again using a dry cloth.
 - (d) Cover heater completely with a large plastic bag to protect from dust.

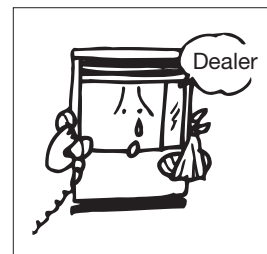

4. To store heater in another location,
 - (a) Disconnect heater.
 - (b) FF-55T: Remove all fuel from the fuel sub tank and clean the fuel acceptance fitting.
FF-55: Close the main tank valve. Remove all fuel from the fuel sump and clean the fuel strainer.
 - (c) FF-55T: Disconnect flue pipe from the heater.
FF-55: Disconnect fuel line and flue pipe from the heater.
NOTE: Fuel remaining in the fuel line may flow out when fuel line is disconnected.
Have a container ready to catch drainage.
 - (d) Remove any soot accumulated in the flue pipe using a brush and/or vacuum cleaner.
 - (e) Wipe off any stains or dust on heater with a damp cloth, then wipe once again using a dry cloth.
 - (f) Put the heater in the original shipping box, and store in a dry place. If original shipping box is not available, cover the heater completely with a large plastic bag to protect from dust during storage.
 - (g) Cover exhaust and air intake openings of the flue pipe by using optional caps.
(Part #17212661 and #17212656)

TRANSPORTATION

Take the following measures to avoid fuel leakage during the transportation of the heater.



- ALWAYS move the heater in an upright position.
- ALWAYS drain fuel from the fuel sub tank cap (*optional) (Part #17217535) before transportation. (FF-55T)
- ALWAYS drain fuel from the fuel sump before transportation. (FF-55)

SECTION I: INSTALLATION

GENERAL DESCRIPTION: The FF-55T/FF-55 is designed to be installed in an outside wall so the full advantage of installation simplicity can be made with the "Flue Pipe", which eliminates the need for tall chimney type flues. No hearth or fire surround is required.

STANDARD INSTALLATION PARTS

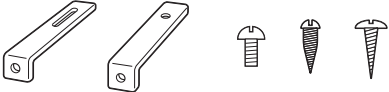
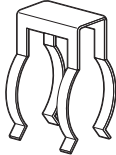
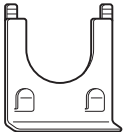
The following standard installation parts are enclosed with heater. For alternate installation methods, you may need to purchase additional accessories which are available from your TOYOTOMI dealer. See "Accessory Parts".

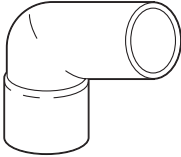
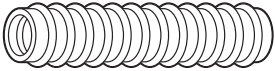
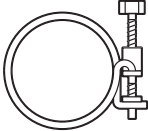
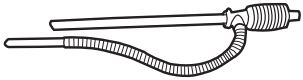
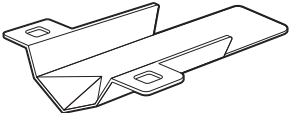
 <p>Wall Bracket (2 sets) (PART #17212589) Tapping Screw (1) (PART #17208678) Bind Tapping Screw (1) (PART #17187555) Wood Screw (1) (PART #17206066)</p>	 <p>Pipe Holder (1) (PART #17212685)</p>
 <p>Pipe Stopper (1) (PART #17219378)</p>	 <p>Wood Screw (3) (PART #17206066) Flue Pipe (1) (PART #17224296) Exhaust Air Cap (1) (PART #17212661) Intake Air Cap (1) (PART #17212656)</p>
 <p>Bent Joint (L) (1) (PART #17212798) Insulating Cover (PART #17206025)</p>	 <p>L-shaped Hose (2) (PART #17212692)</p>
 <p>Inlet Hose (1) (PART #17206091)</p>	 <p>Hose Band (2) (PART #17212677) (Hose Clamp)</p>
<p>(FF-55T)</p>  <p>Manual Fuel Pump (1) (PART #17027727)</p>	<p>(FF-55)</p>  <p>Oil Catch (1) (PART #17185025)</p>

INSTALLATION ADVICE

- Intake air and exhaust flue pipe openings of the Flue Pipe must be fully exposed to outside. The Flue Pipe must not vent into a chimney, garage, basement, under-floor or ceiling cavity, or any enclosed area, or be installed vertically, because the Flue Pipe is a "Heat Exchanger" which causes condensate to form in the exhaust pipe, and which must drain to outside.

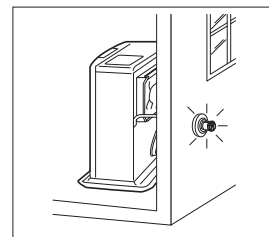

- Install Flue Pipe. Note the volume and temperature of the hot exhaust gas that the exhaust pipe discharges to outside, is minimal, and does not normally present any problems.

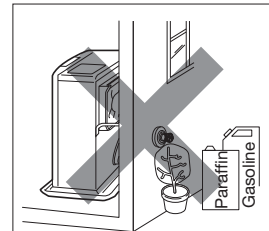

- Before making a hole in the wall for the Flue Pipe ensure the wall cavity is free of electrical wires, gas pipes and other obstacles. Drilling a 5 mm "pilot hole" from inside enables the final hole (and any associated "mess") to be completed from outside.

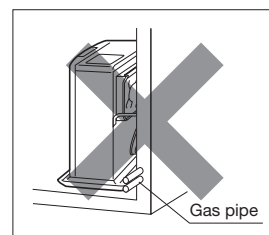

- DO NOT install Flue Pipe where the air supply or exhaust gas outlet might become covered by snowdrifts, fouled by outdoor debris, or directly exposed to winds over 50 kph.

IMPORTANT:
In areas of heavy snow falls, ground surface clearance must be increased according to average snow falls.

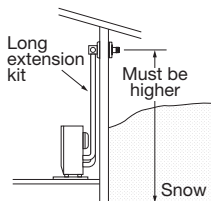

IMPORTANT:
In open area with strong wind, a wind break may be necessary.

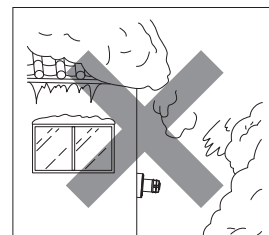
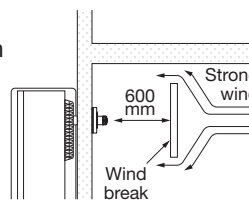

- NEVER install the Flue Pipe below the heater.

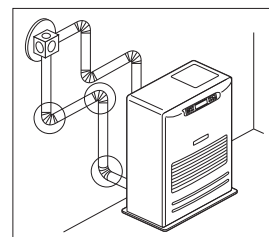
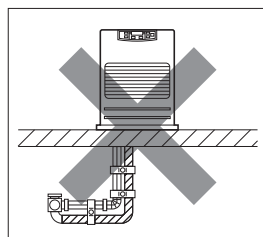
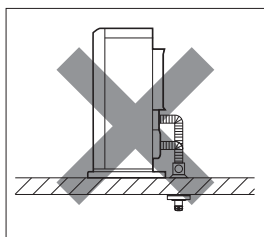

- Total length of any Extension Pipe Kits (accessories L, M or S) between heater and Flue Pipe must not exceed 3 m, with not more than 3 × 90° bends.

NOTE: When using Extension Pipe Kits type L, M or S always insulate hot exhaust pipe with the insulating cloth cover supplied. (More insulation may be required by Local Authority).

- For all heater installations, the Flue Pipe must always be installed. It must be horizontal with slight fall to outside ... **NEVER vertically.**

INSTALLATION OF HEATER AND FLUE PIPE

- A) Before commencing any installation work, check that the proposed installation will comply with Building Code requirements and Local Consent Authority rules that may apply to vented heaters in your area. (Check your Local Authority website, or consult your Installer / Supplier.)
- B) The Flue Pipe is designed to be installed through the wall of any conventional building cladding, including Brick, Hebel, Linear, Gibraltar and Plaster Board, Tiles, Weatherboard, Plastered Polystyrene, and metal profiles etc.
- C) The FF-55T / FF-55 heater is designed to be operated at altitudes up to 900 m, above sea level. For installation at altitudes between 900 m and 1500 m, adjustments by authorized serviceperson is necessary. Consult your supplier for advice.
1. Select heater location. Ensure minimum clearances as indicated below between heater and nearest combustible materials. Provide service access to clean the rear circulation air filter, integral fuel strainer (FF-55) and reset button (FF-55).

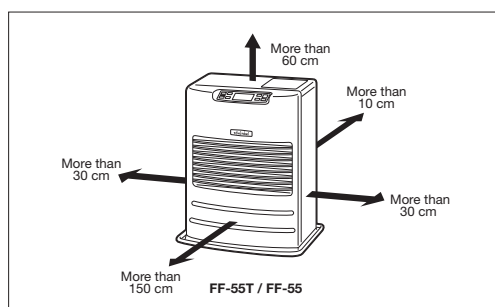

Fig. 1

2. Ensure the outdoor flue discharge area is clear of anything that might be affected by the hot flue exhaust gas. (See Fig. 2 and 3.)

The Flue Pipe (as in Fig. 2), is for wall thickness from 130 mm to 320 mm.

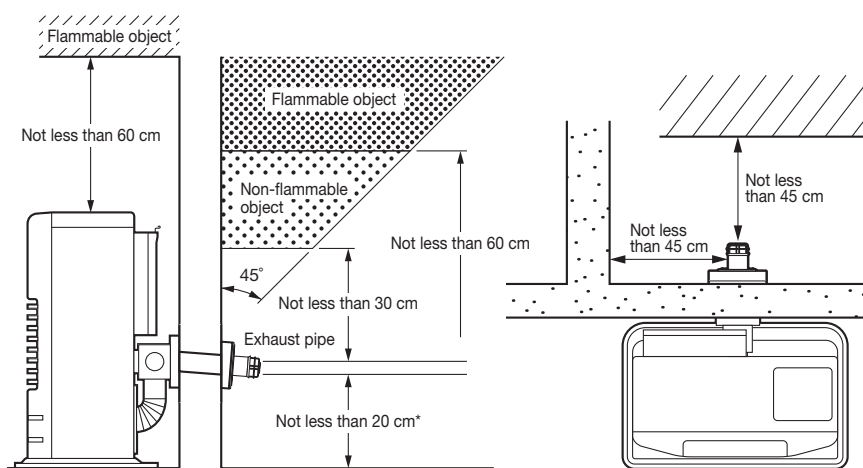

Fig. 2

Fig. 3

Flue Pipe Installation

3. A room temperature sensor is provided with approx. 2.5 meters long extension wire. It is located on the rear of the cabinet. Make sure that the extension wire is not touching the exhaust pipe. The room temperature sensor can be installed with a wood screw. Screw down the wood screw provided with the heater into the desired location on the wall. Hook the back of the room temperature sensor.

NOTE: Choose a location for the sensor that is not in the path of direct sunlight, drafts or the flow of warm air from the heater.

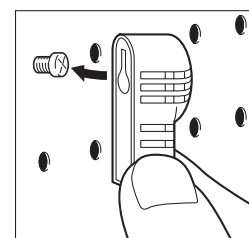

Read installation manual before installing heater.

TOYOTOMI CO., LTD.

5-17, Momozono-cho, Mizuho-ku, Nagoya, 467-0855 Japan
<http://www.toyotomi.jp>

Rev. 06/17

Printed in Japan
8373002060